

FLEEXILOOP
Manuel d'installation

FLEEX.INOX



EN795:2012,A

FLEEX.INOX
FLEEXILOOP

L'ECHELLE
EUROPEENNE

L'ECHELLE EUROPÉENNE

Parc Marcel Dassault
34430 Saint Jean de Védas
France

L'ECHELLE EUROPÉENNE

Tél : 04 67 27 36 55

Fax : 04 67 07 50 05

info@echelle-europeenne.com

www.echelle-europeenne.com

MoA-117-07



1

DE Die Anweisungen der **Montageanleitung [1]** und Sicherheitshinweise [2] sind strikt einzuhalten.

EN The information contained in the **assembly instructions [1]** and safety instructions [2] must be strictly observed.

NL De aanwijzingen in de **montagehandleiding [1]** en de veiligheidsvoorschriften [2] moeten strikt worden nageleefd.

ES Respete estrictamente las instrucciones del **manual de montaje [1]** y las indicaciones de seguridad [2].

IT È assolutamente necessario attenersi alle **istruzioni di montaggio [1]** e alle norme di sicurezza [2].

TR **Montaj kılavuzunun [1]** ve güvenlik uyarılarının talimatlarına [2] kesinlikle uyulmalıdır.

NO Det er svært viktig at instruksjonene i **monteringshåndboken [1]** og sikkerhetsheftet [2] følges.

RO Indicațiile din **instrucțiunile de montare [1]** și din broșura cu indicații de siguranță [2] trebuie respectate cu strictețe.

FI **Asennusohjeen [1]** ja turvaohjevikoksen [2] ohjeita on ehdottomasti noudatettava.

ZH 必 格遵守 装配 明 和 安全 知 中的 指示

FR Les **instructions de la notice de montage [1]** et les consignes de sécurité [2] doivent être formellement respectées.

PL Należy ściśle przestrzegać **instrukcji montażu [1]** i wskazań bezpieczeństwa [2].

DA **Montagevejledningen [1]** anvisninger som også sikkerhedsanvisningerne [2] skal overholdes.

CZ Je nutné striktně dodržovat instrukce obsažené v **montážním návodu [1]** a v bezpečnostních pokynech [2].

EL Πρέπει να τηρούνται αυστηρά οι οδηγίες του **εγχειριδίου συναρμολόγησης [1]** και των υποδείξεων ασφαλείας [2].

SK Dôležité dodržiavajte pokyny **montážneho návodu [1]** a bezpečnostné pokyny [2].

SE Anvisningarna till **monteringsanvisningen [1]** och säkerhetsmanualen [2] måste iaktas under alla omständigheter.

RU Необходимо строго соблюдать требования **руководства по монтажу [1]** и инструкции по безопасности [2].

HI इंस्ट्रक्शन के निर्देशों [1] और सुरक्षा निर्देश मैनुअल [2] में दिये गये निर्देशों का सख्ती से अनुसरण किया जाना चाहिए।

SQ

يجب الالتزام بالتعليمات الواردة في دليل التركيب [1] وكتيب إرشادات السلامة [2] بمنتهى الدقة.

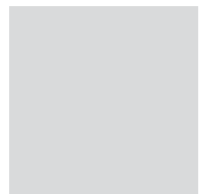
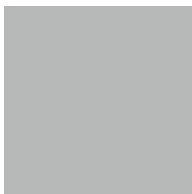
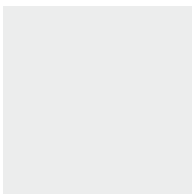
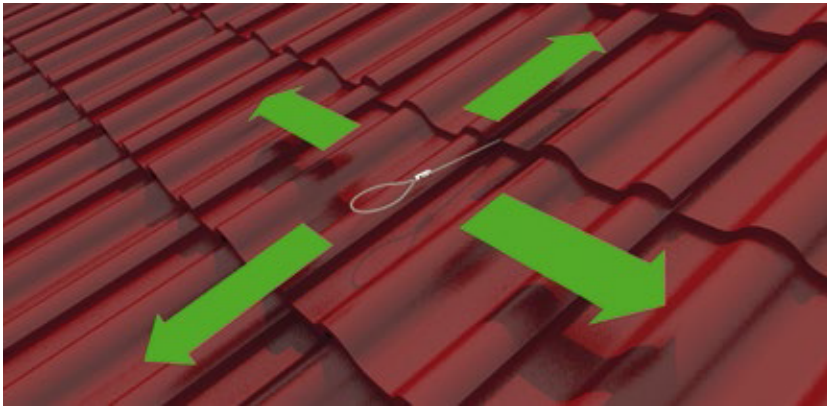

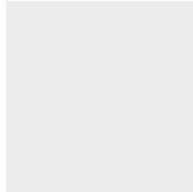
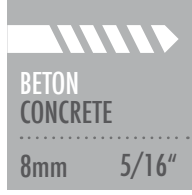
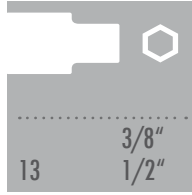

2x

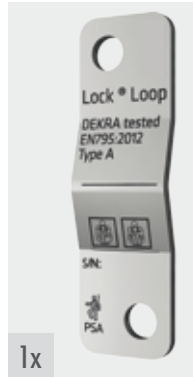

1x



1x

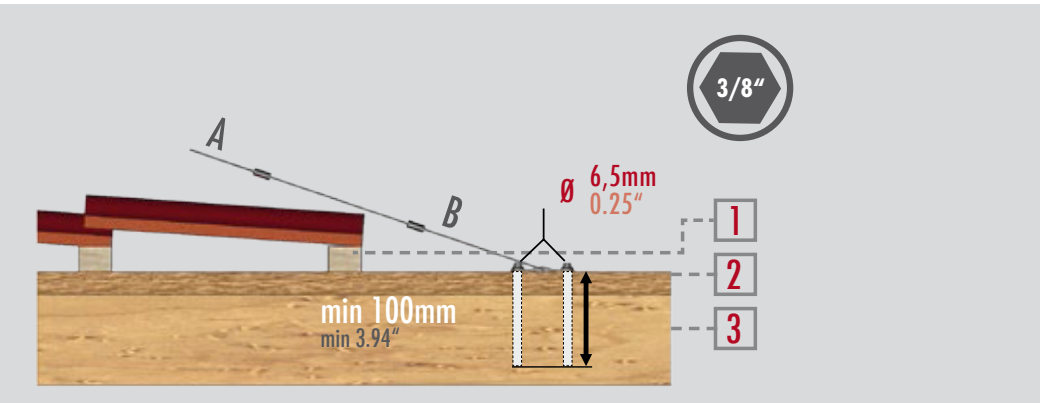

1

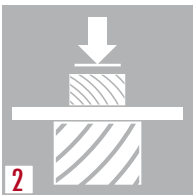

2



3

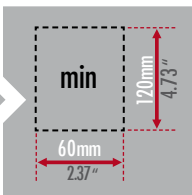

1

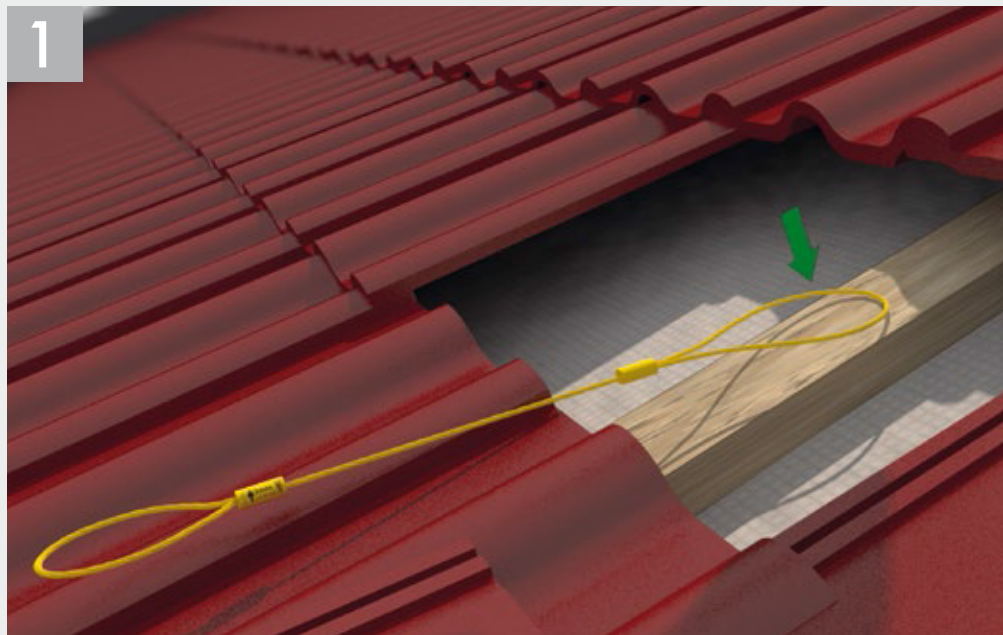

2

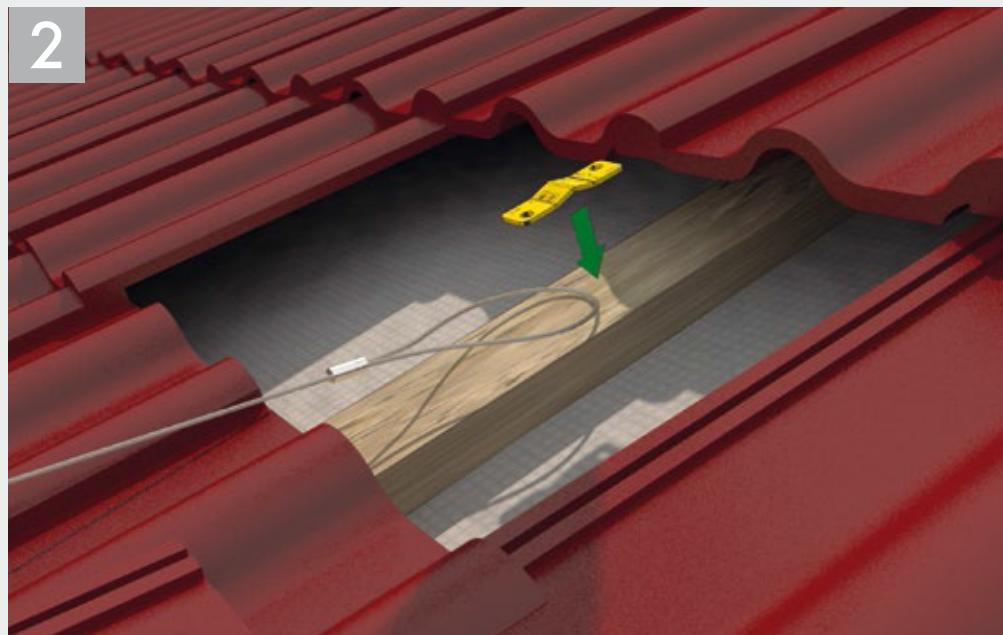

3a

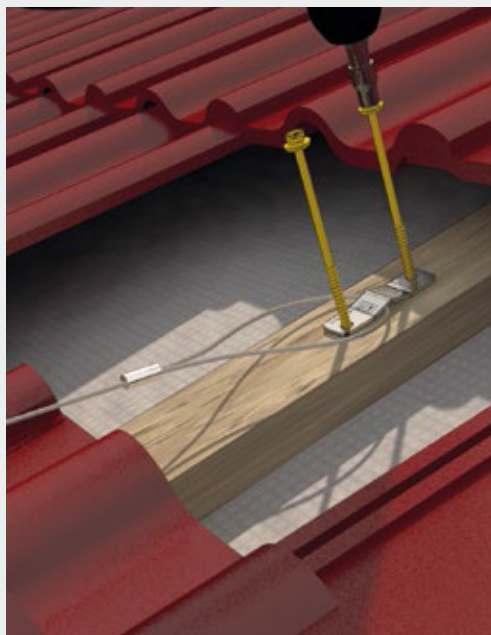
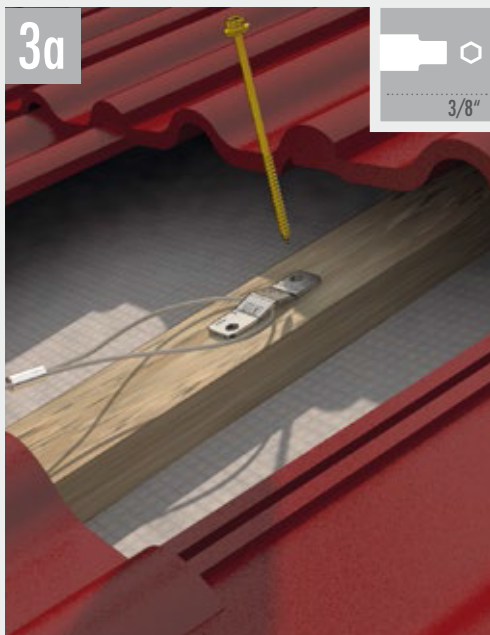

3b



4

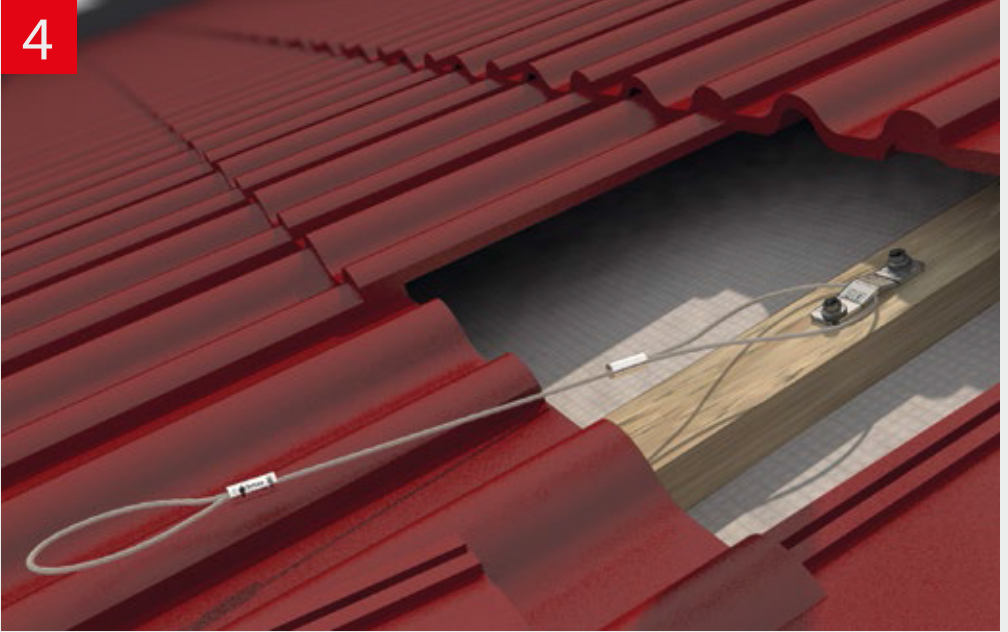

FLEXILOOP

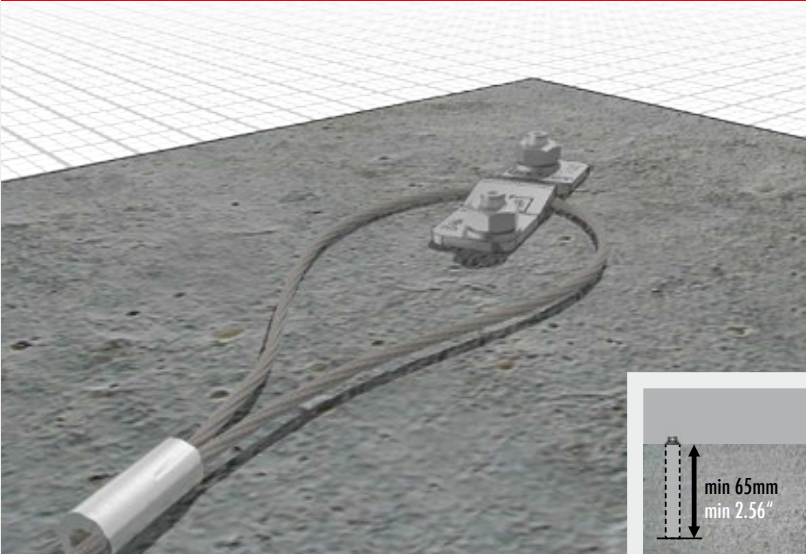

BETON
CONCRETE

8mm 5/16"

13 1/2"

min 65mm
min 2.56"

20 Nm
15 lbf ft